

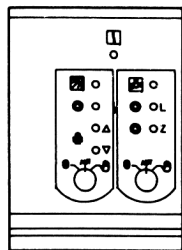







 Řídicí napětí 230V
 Malé napětí



poloha přepínače		k4	k6
0			
AUT	regulační provoz čerpadlo	Regulační provoz	
			

poloha přepínače		k1	k2	k3
0				
AUT	regulační provoz čerpadlo	regulační provoz chladnější	regulační provoz tepleji	
				



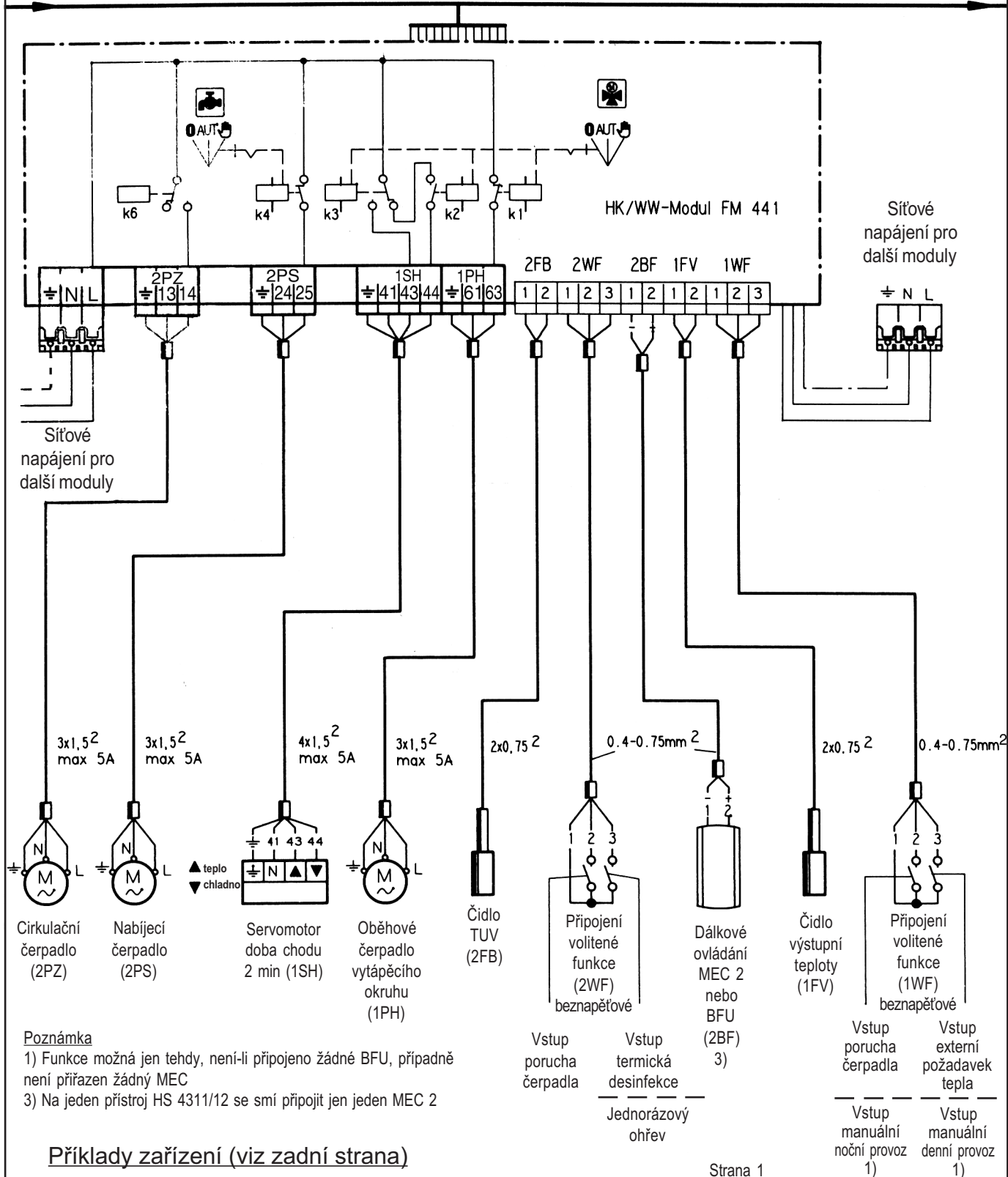
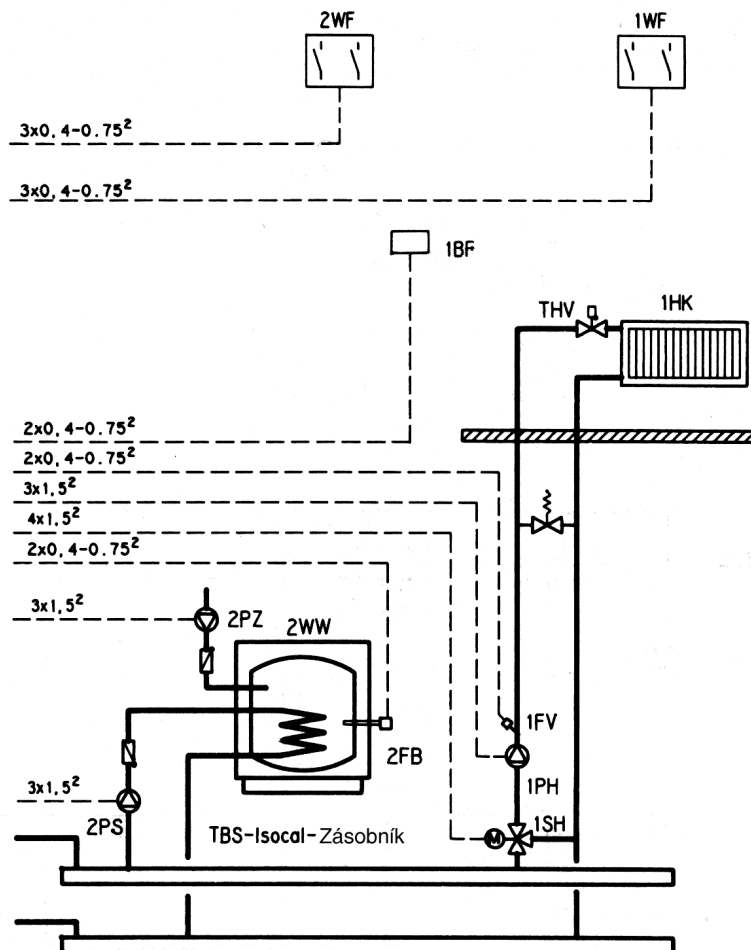

THV Termostatický ventil
 HK Vytápěcí okruh
 WW Příprava TUV